

Dear Customer,

Thank you for purchasing this Smeg 50's Style coffee machine.

By choosing one of our products, you have selected an appliance which combines iconic style with innovative technical design and attention to detail.

A Smeg appliance coordinates perfectly with other Smeg products, or works equally great as a standalone statement piece in your kitchen.

We hope you enjoy using your new appliance!

For further information on the product, please visit [www.smeg.com](http://www.smeg.com) or [www.smeg50style.com](http://www.smeg50style.com).

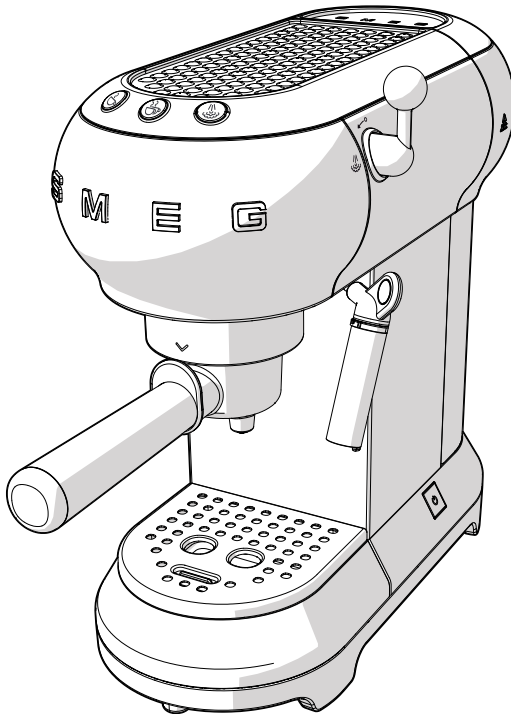

Model ECF01  
Coffee Machine

# Contents

<b>1 Instructions</b>	<b>26</b>
1.1 Introduction	26
1.2 This user manual	26
1.3 Intended use	26
1.4 General safety instructions	26
1.5 Manufacturer liability	29
1.6 Identification plate	29
1.7 Disposal	29
<b>2 Description</b>	<b>30</b>
2.1 Product description	30
<b>3 Use</b>	<b>31</b>
3.1 Before first use	31
3.2 First use	32
3.3 How to prepare espresso coffee	33
3.4 How to prepare a cappuccino	35
3.5 How to dispense hot water	36
3.6 Accessing the settings menu and changing the settings	36
3.7 How to cool down the boiler	39
<b>4 Cleaning and maintenance</b>	<b>40</b>
4.1 Instructions	40
4.2 Cleaning the body of the coffee machine	40
4.3 Cleaning the coffee machine components	40
4.4 Descaling	42
4.5 What to do if...	43

We advise you to read this manual carefully, as it contains all the instructions for maintaining the appliance's aesthetic and functional qualities.

For further information on the product: [www.smeg.com](http://www.smeg.com)



# Instructions

## 1 Instructions

### 1.1 Introduction

Key information for the user:

#### Instructions



General information on this user manual, on safety and final disposal.

#### Description



Appliance description

#### Use



Information on using your appliance.

#### Cleaning and care



Information for proper cleaning and maintenance of the appliance.



Safety instructions



Information



Advice

### 1.2 This user manual

This user manual is an integral part of the appliance and must therefore be kept in its entirety and in an accessible place for the whole working life of the appliance.

### 1.3 Intended use

The appliance can be used to prepare espresso and cappuccino coffee using ground coffee or coffee soft pods. Every other use is considered improper. Do not use the appliance for anything other than its intended use.

### 1.4 General safety instructions

- The appliance must not be used by persons (including children) with reduced physical, sensory or mental capabilities or with a lack of experience and knowledge, unless appropriately supervised, or instructed on the safe use of the appliance by a person responsible for their safety.
- Children must be supervised at all times to ensure they do not play with the appliance.
- Cleaning and maintenance of the appliance must not be performed by children, unless closely supervised.



- Never submerge the appliance in water.
- This appliance is intended for household use. Moreover, it cannot be used:
  - in kitchen areas provided for employees in shops, offices and other working environments;
  - in farms/farm stay facilities
  - by guests in hotels, motels and residential environments;
  - in bed and breakfasts.
- If the power cord is damaged, contact technical support to arrange for this to be replaced in order to avoid any possible hazards.
- Keep the appliance and its cord out of reach of children under the age of 8 years.
- Children must never play with the appliance.
- The appliance may be used by people with reduced physical, sensory or mental capabilities or lack of experience and knowledge if they have been given supervision or instruction concerning use of the appliance in a safe way and if they understand the hazards involved.
- Disconnect the appliance from the power socket before assembly, disassembly and cleaning.

## Only for European markets:

- This appliance may be used by children from the age of 8 provided they are supervised or instructed on the safe use of the appliance and they understand the associated risks.
- Cleaning and maintenance may be performed by children from the age of 8 as long as they are appropriately supervised.



## Hot surfaces

- Surfaces marked with this symbol will become hot during use. This symbol is only present only on some models.





## Instructions

### For this appliance

- Follow all safety instructions in order to use the appliance safely.
- Read this user manual carefully before using the appliance.
- Switch off the appliance immediately after use.
- Do not leave the coffee machine unattended during use.
- Always disconnect the coffee machine from the power socket if it is left unattended and before assembly/disassembly of components or cleaning.
- Unplug the coffee machine before cleaning it and if you notice any fault.
- Let the coffee machine cool down before cleaning.
- Do not use the coffee machine without the tank fitted or if there is no water in the tank.
- Leave at least 3 cm of space between the coffee machine and any walls to the rear or side, and 15 cm clearance above the coffee machine.
- Danger of burns! The coffee machine generates heat and produces hot water and steam during its operation.
- Danger of burns! Do not touch the cup warmer shelf while the appliance is running.
- Do not use the coffee machine with parts or accessories of other manufacturers.
- Only use original spare parts. The use of spare parts not approved by the manufacturer could lead to fires, electric shocks or personal injury.
- Only place the coffee machine on level and dry surfaces.
- Avoid getting the coffee machine wet and do not spray liquids onto it. In the event of contact with liquid, immediately switch off the power at the socket or main breaker and dry the appliance thoroughly: Electric shock hazard!
- Do not use harsh detergents or sharp objects to clean the coffee machine.
- Do not make any modifications to the appliance.
- Never try to put out a fire or flames with water: turn off the appliance and remove the plug from the socket, and smother the flames with a fire blanket or other appropriate cover.
- Prevent the power cord from coming into contact with sharp edges.
- Never position the appliance above or near gas or electric hob burners when they are hot or in use, inside an oven or near other heat sources.
- Do not position the appliance near sinks or taps.



## 1.5 Manufacturer liability

The manufacturer shall not be liable for injuries or property damage caused by:

- Use of the appliance other than that specified
- Failure to read the user manual
- Tampering with any part of the appliance
- Use of non-original spare parts
- Failure to observe the safety instructions

## 1.6 Identification plate

The identification plate bears the technical data, serial number and brand name of the appliance. Do not remove the identification plate for any reason.

## 1.7 Disposal



This appliance must be disposed of separately from other waste (Directive 2012/19/EU). The

appliance does not contain substances in quantities sufficient to be considered hazardous to health and the environment, in accordance with current European directives.

- **Old appliances do not belong in household waste!** To comply with current legislation, old appliances, on reaching the end of their useful lives, should be taken to a disposal facility where they can be sorted. This allows precious materials from old appliances to be recycled and helps protect the environment. For further information, contact the relevant local authorities or your nearest waste recycling centre.

Our appliances are packed in non-polluting and recyclable materials.

- Take these packing materials to the appropriate recycling centre.



### Plastic packaging Danger of suffocation

- Do not leave the packaging or any part of it unattended.
- Do not let children play with the plastic bags.



### Electrical voltage Danger of electrocution

- Disconnect the mains supply.
- Unplug the appliance.



# Description

## 2 Description

### 2.1 Product description

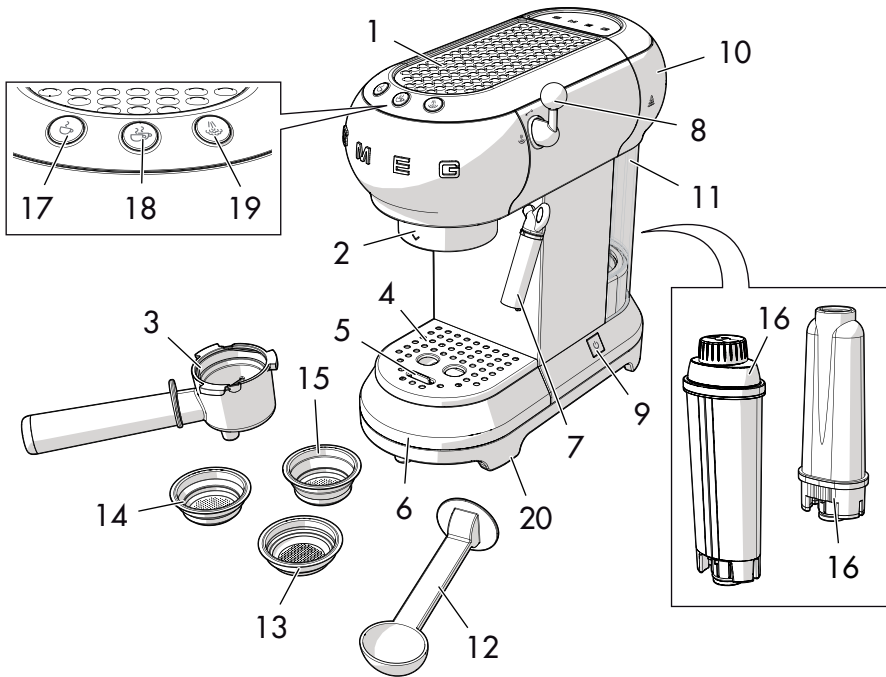

#### Model ECF01 - Coffee Machine

- |   |  |
|---|--|
| 1 Cup warmer shelf  | 11 Water tank (1 litre)                                    |
| 2 Boiler outlet   | 12 Measuring/tamping scoop                                 |
| 3 Filter holder   | 13 Coffee soft pod filter                                  |
| 4 Steel cup holder tray                                     | 14 Ground coffee filter, 1 cup                             |
| 5 Float   | 15 Ground coffee filter, 2 cups                            |
| 6 Stainless-steel drip tray                                 | 16 Water softener filter (optional)                        |
| 7 Hot water/steam nozzle and frothing nozzle for cappuccino | 17 One-cup coffee button (white light)                     |
| 8 Steam knob  | 18 Two-cup coffee button (white light)                     |
| 9 ON/OFF switch   | 19 Steam button (white light)/Descal button (orange light) |
| 10 Water tank lid   | 20 Non-slip feet   |



### 3 Use



#### Danger of electrocution

- Plug into an earthed 3-pin socket.
- Do not remove the earth pin.
- Do not use an adapter.
- Do not use an extension cord.
- Failure to observe these warnings can lead to fire, electrocution or even death.

#### 3.1 Before first use

1. Remove any labels and stickers from the coffee machine.
2. Carefully wash and dry the components of the coffee machine (see "4 Cleaning and maintenance").
3. Remove the lid (1) by pulling it upwards, then remove the tank (2).

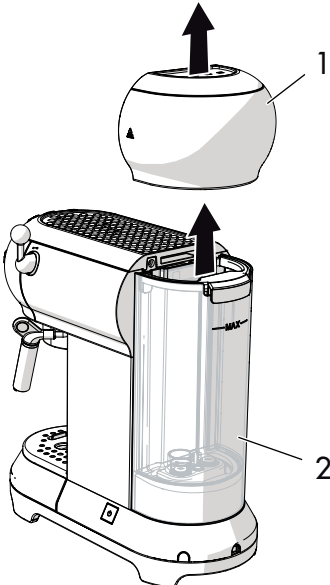

4. Fill the tank (2) with cool, clean water directly from the tap or using a jug, ensuring you do not exceed the maximum level on the tank.

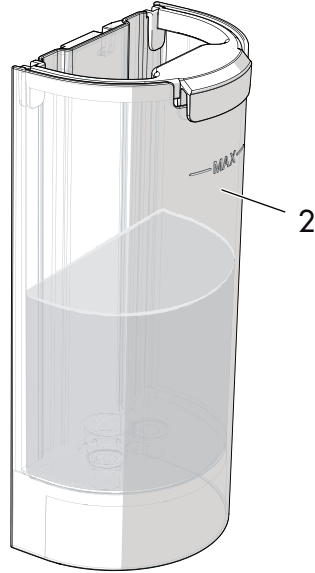

#### Danger of malfunction

- Do not use the coffee machine without the tank fitted or if there is no water in the tank.



The components intended to come into contact with food are made of materials that comply with the provisions of current legislation.



## 3.2 First use

1. Switch on the coffee machine by pressing the ON/OFF switch (1): the lights of the three buttons (2), (3) and (4) will flash in sequence.

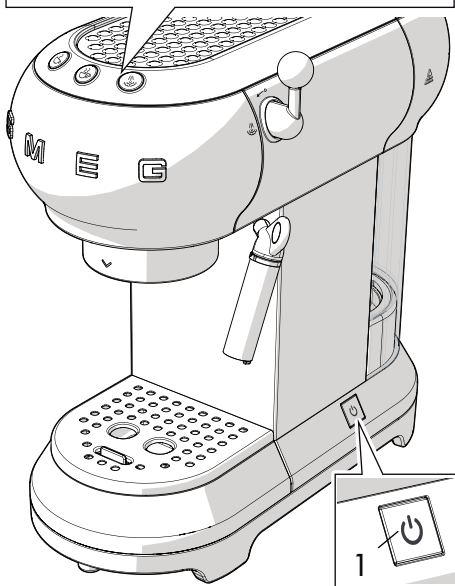
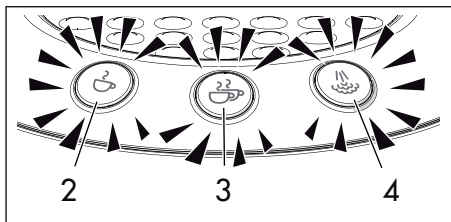

2. The lights (2) and (3) flash to indicate that the machine is warming up to the set temperature. The coffee machine is ready for use as soon as the lights stop flashing and are lit steadily.

**i** On first use, rinse the internal circuits:

- Attach the filter holder to the coffee machine.
- Place a container under the coffee dispensing spouts and press .
- Repeat this process 5 times.

**i** Rinsing of the internal circuits is also recommended when the coffee machine has not been used for a long period of time.

3. Position a container under the hot water/steam nozzle (4).
4. Turn the steam knob (5) to the  position and dispense 100 ml of water.



5. Return the steam knob (5) to the ← position.

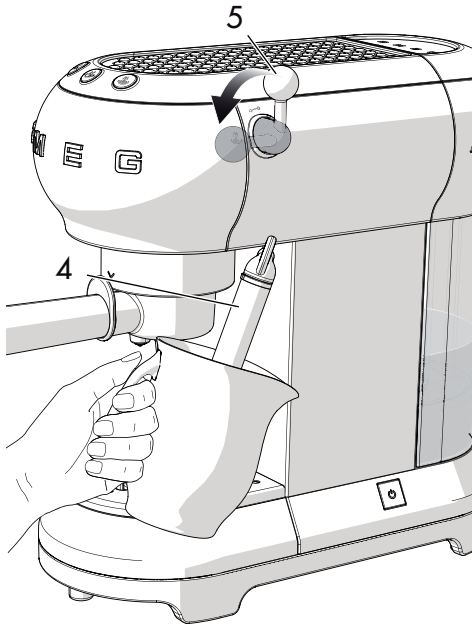

**i** Prepare 4-5 coffees or 4-5 cappuccinos to obtain best results.

## Filters

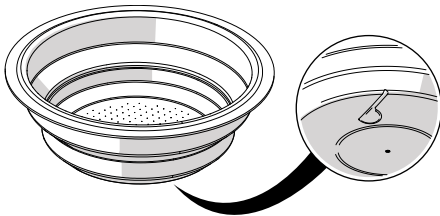

The coffee machine is provided with three filters: one for one cup, one for two cups and one for soft pods.

The corresponding symbol is indicated on the bottom of each filter.



## 3.3 How to prepare espresso coffee

Ground coffee:

1. Insert the filter for ground coffee (1) in the filter holder (2), choosing between the one-cup filter  and two-cup filter .

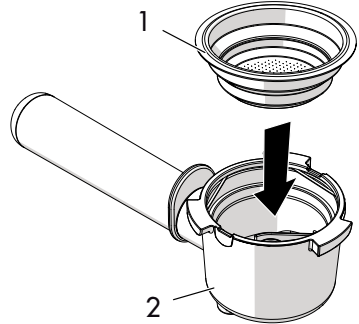

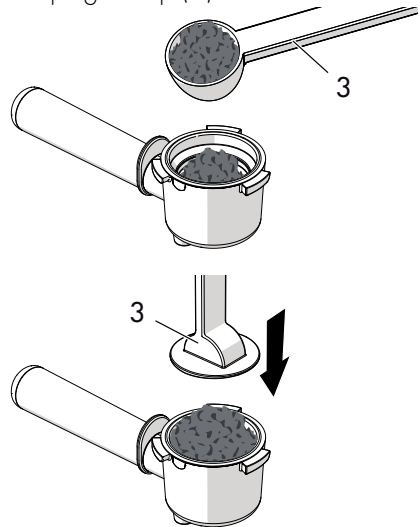

2. Tamp down the ground coffee using the tamping scoop (3).





EN

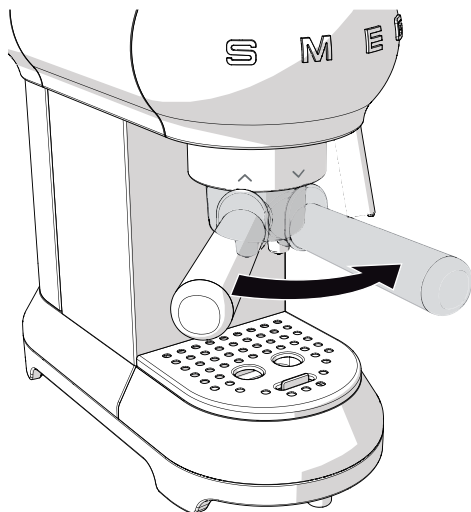

## Use

3. Remove any excess coffee from around the edge of the filter holder. Attach the filter holder by lining up the handle with  and turning it to the right up to the  position.



4. Position the cup(s) under the filter holder spouts and press the  or  dispense button.

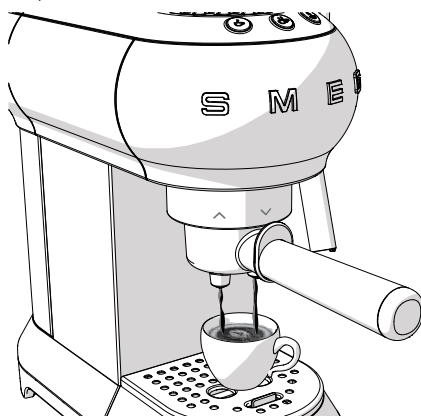

### Danger of burns

- To avoid sprays, do not remove the filter holder while the machine is running; wait for a few seconds after dispensing has stopped.



- For one cup, fill the filter with a level measure of coffee (approx. 7 grams).
- For two cups, fill the filter with two level measures.
- To obtain a strong coffee, tamp down the coffee firmly.
- To obtain a lighter coffee, tamp down the coffee less.



### Coffee soft pods:

1. Insert the filter for soft pod coffee  into the filter holder.
2. Insert the soft pod into the filter holder, positioning it as centrally as possible.
3. Proceed in the same manner as for ground coffee.



### Danger of burns



- To avoid sprays, do not remove the filter holder while the machine is running: wait for a few seconds after dispensing has stopped.



- The delivery of coffee can be stopped at any point by pressing the dispense button again.
- To increase the quantity of coffee in the cup, hold down the dispense button.

### 3.4 How to prepare a cappuccino

1. Prepare an espresso coffee in a large cup.
2. Press the  button: the light will flash.
3. Fill a container with 100 ml of semi-skimmed milk for each cappuccino you wish to prepare.

4. When the  light stops flashing and is lit steadily, position an empty container underneath the frothing nozzle for cappuccino **(1)** and then open the steam knob **(2)** to the  position to discharge any water present, before closing the knob again.

5. Position the container with milk underneath the frothing nozzle for cappuccino **(1)** then immerse the frothing nozzle a few millimetres into the milk.

Turn the knob **(2)** to the  position and slowly move the container upwards to obtain creamier foam.

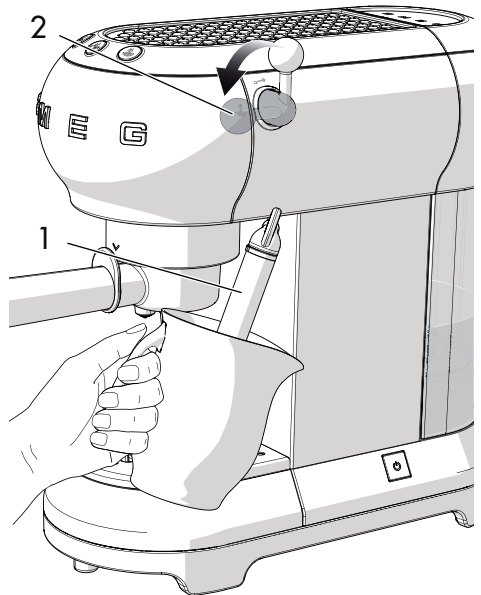





## Use

6. Once the volume of milk has doubled, immerse the frothing nozzle for cappuccino all the way and heat the milk up to 60°C. Stop the steam by turning the steam knob to the right.
7. Pour the milk into the cups with the espresso.



### 3.5 How to dispense hot water

1. Turn the machine on using the ON/OFF switch and wait until the coffee dispensing indicator lights are no longer blinking.
2. Position a container underneath the frothing nozzle for cappuccino.
3. Turn the steam knob to the  position to let out the hot water.



- Do not dispense steam for longer than 60 seconds.

### 3.6 Accessing the settings menu and changing the settings

1. Ensure that the machine is ready for use, then press and hold the  button for 10 seconds until the three buttons start flashing: the machine is now in settings mode.
2. Adjust the machine settings to your requirements.
3. To exit the menu, just wait 15 seconds without pressing any buttons.















- To prepare more than one cappuccino, first prepare all the necessary cups of espresso, then steam the milk for all the cappuccinos together.
- For reasons of hygiene, it is advisable to clean the frothing nozzle for cappuccino after use.
- Discharge any milk residue by turning the steam nozzle to let the steam out.
- Do not dispense steam for longer than 60 seconds.



### Setting the coffee temperature



1. Access the settings menu.
2. Press the  button to select the coffee temperature. The lights for the current setting will turn on:

Lights	Temperature setting
  	Low
  	Medium
  	High

3. The lights will start flashing in sequence.
4. Press the button corresponding to the required temperature: low , medium  or high .
5. The  button flashes to indicate that the selection has been stored.

### Setting the quantity of coffee









To modify the quantity of coffee dispensed by the machine:

1. Position one or two cups under the filter holder spouts.
2. Press the button for one cup  or two cups  and hold it down.
3. The machine will start dispensing coffee.

4. Release the button as soon as the required quantity of coffee is reached.
5. The light flashes to indicate that the selected quantity has been stored.

### Setting the water hardness

1. Access the settings menu.
2. Press the  button to select the water hardness. The lights for the current setting will turn on:

Lights	Water setting
  	Soft
  	Medium
  	Hard

3. The lights will start flashing in sequence.



# Use

4. Press the relative button to select the water hardness:



soft



medium



hard

<10°dH

10°dH -  
20°dH

> 20°dH

<18°FH

18°FH - 36°FH

> 36°FH

< 180 mg/l  
CaCo3

180-300 mg/l  
CaCo3

360 mg/l  
CaCo3

5. The  button flashes to indicate that the selection has been stored.

## Setting the automatic shut-off time

In order to save energy, the coffee machine will turn itself off when it has not been used for a certain period of time.

To turn the appliance back on, press any button on the control panel.

To set this time:

1. Access the settings menu.
2. Press  to select the auto shut-off time. The lights for the current setting will turn on:

Lights	Time setting
--------	--------------







9 minutes



30 minutes





3 hours

3. The lights will start flashing in sequence.
4. Press the button corresponding to the time you wish to set: 9 minutes , 30 minutes  or 3 hours .
5. The  button flashes to indicate that the selection has been stored.



### Restoring factory default values

To return the machine to its factory settings:

1. Access the settings menu.
2. Turn the steam knob to the  position.
3. Press the  button: the three lights will flash to indicate that the factory defaults have been reset.
4. Return the steam knob to the  position.

### 3.7 How to cool down the boiler

The boiler must be cooled down if you wish to prepare a coffee immediately after frothing milk.

If this procedure is not performed, the coffee dispensed will taste burnt.

1. Position a container underneath the frothing nozzle for cappuccino and open the steam knob to dispense hot water.

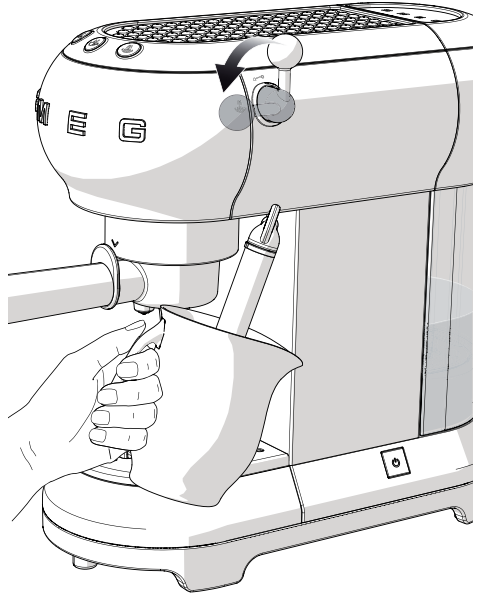

2. Hot water will stop coming out as soon as the boiler has cooled down.
3. Close the steam knob again and prepare the coffee.



# Cleaning and care

## 4 Cleaning and maintenance

### 4.1 Instructions



**Improper use**  
**Danger of electrocution**

- Unplug the coffee machine before cleaning it.
- Do not immerse the coffee machine in water or other liquids.
- Let the coffee machine cool down before cleaning.



**Improper use**  
**Risk of damage to surfaces**

- Do not use steam jets to clean the coffee machine.
- Do not use cleaning products containing chlorine, ammonia or bleach on parts with metal surface finishes (e.g. anodised, nickel- or chrome-plated).
- Do not use abrasive or corrosive detergents (e.g. powder products, stain removers and metallic scourers).
- Do not use rough or abrasive materials or sharp metal scrapers.

### 4.2 Cleaning the body of the coffee machine

To keep the outer surface of the coffee machine in good condition, it should be cleaned regularly after use. Let the appliance cool down first. Clean with a soft, damp cloth.

### 4.3 Cleaning the coffee machine components

#### Cleaning the drip tray

The drip tray is equipped with a red float (1) which sticks out of the cup holder tray when the maximum liquid level is exceeded.

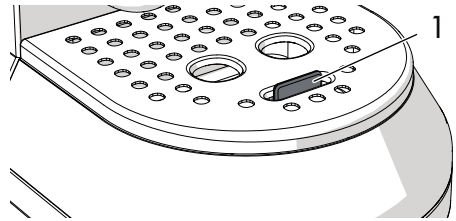

1. Remove the cup holder tray (2) and then remove the drip tray (3) to empty it.

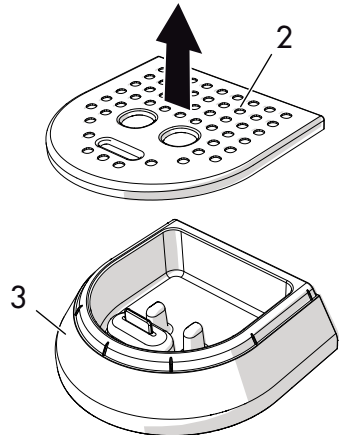

2. Clean the drip tray with a cloth and then reposition it together with the cup holder tray.

#### Cleaning the coffee filters

Clean the coffee filters regularly under running water. If the holes are blocked, clean them with a pin or a brush.



## Cleaning the frothing nozzle for cappuccino

Clean the frothing nozzle for cappuccino immediately after use.

1. Turn the steam knob to let a little steam out and drive out any milk inside the nozzle.
2. Shut off the coffee machine by pressing the **ON/OFF** switch.
3. Hold the tube of the frothing nozzle (1) still with one hand and use the other to rotate the frothing nozzle (2) clockwise and pull it off downwards.

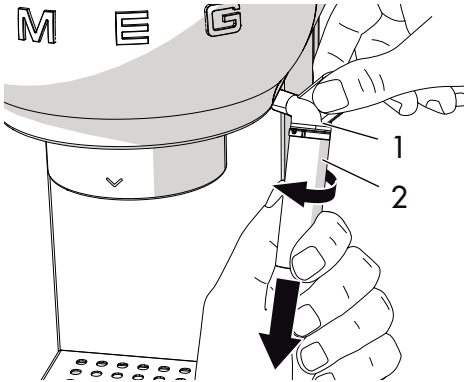

4. Remove the rubber connecting nozzle (3) from the frothing nozzle tube by pulling it downwards.

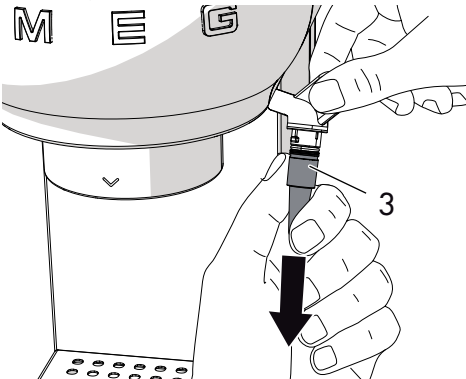

5. Wash the frothing nozzle and rubber connecting nozzle thoroughly with warm water.
6. Check that the hole (4) is not blocked.

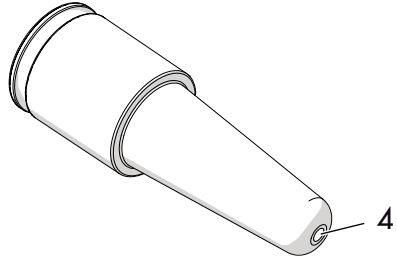

7. Insert the rubber connecting nozzle (3) back into the frothing nozzle tube (1) then replace the frothing nozzle (2) by pushing it upwards and rotating it anticlockwise.
8. Refit the frothing nozzle in its housing by following the cleaning instructions in reverse.

## Cleaning the boiler outlet

The boiler outlet must be rinsed every 200 coffees made by dispensing approximately 500 ml of water by pressing the coffee dispense button without adding ground coffee or a soft pod.

## Cleaning the water tank







Clean the water tank once a month using a moist cloth and mild detergent.





## Cleaning and care

### 4.4 Descaling

The coffee machine needs descaling when the orange light on the  button lights up.

1. Fill the water tank with a solution of water and descaler, following the instructions on the package.
2. Press the **ON/OFF** switch.
3. Remove the filter holder and position a container underneath the frothing nozzle.
4. Wait for the  or  lights to come on steadily.
5. Press the  button and hold for 10 seconds until the three buttons flash in sequence.
6. Turn the steam knob to the  position.
7. Press  to start descaling.
8. The descaling cycle automatically performs a series of rinse cycles at intervals to remove scale from the inside of the coffee machine, continuing until the tank is empty.
9. The descaling cycle will stop and the orange light  will flash.
10. Remove the water tank, empty it and rinse it out.

11. Fill the tank to the maximum level mark and insert it in its housing.
12. Position an empty container underneath the frothing nozzle and check that the steam knob is in the  position.
13. When the tank is empty it means that the rinse cycle is finished, and the orange light  will turn off.
14. Turn the steam knob to the  position.



### Danger of injury

- The descaler contains acid which can irritate the skin and eyes.
- Follow the manufacturer's instructions and safety warnings on the pack to the letter; they will also tell you what to do in the event of contact with skin or eyes.
- Use descaler products recommended by Smeg to avoid damage to the coffee machine.

### Descaling and rinsing the boiler outlet

During the descaling cycle, close the steam knob every so often to make some of the descaling solution come out from the boiler outlet.

During the rinse cycle, close the steam knob every so often to rinse off the boiler outlet.



## 4.5 What to do if...

Problem	Possible causes	Solution
Coffee does not come out	No water in tank.	Fill the tank.
	The filter holes are blocked.	Clean the filter with a brush or pin.
	The tank is not inserted correctly.	Insert the tank correctly in its housing.
	Scale build-up.	Perform a descaling cycle.
The coffee drips out of the filter holder and not the spouts	The filter holder is not inserted correctly, or is dirty.	Insert the filter holder and turn it so it is fully closed. Clean the filter holder.
	The boiler outlet seal is worn.	Have it replaced at an Authorised Service Centre.
	The spout holes are blocked.	Clean the spout holes.
The filter holder will not attach to the coffee machine	The filter has been overfilled.	Use the supplied measuring scoop and use the correct filter.
The coffee machine does not work and all lights flash	Possible fault.	Unplug the coffee machine and contact an Authorised Service Centre.







## Cleaning and care

Problem	Possible causes	Solution
The “crema” of the coffee is light in colour and comes out of the spout very fast	The ground coffee has not been tamped sufficiently.	Tamp the coffee harder.
	There is insufficient ground coffee.	Use a larger quantity.
	The coffee grind is too coarse.	Use only ground coffee for espresso machines.
	Poor quality ground coffee.	Change type of ground coffee.
The “crema” of the coffee is dark in colour and comes out of the spout slowly	The ground coffee has been tamped too hard.	Tamp the coffee with less force.
	There is too much ground coffee.	Decrease the quantity used.
	The boiler outlet or filter is blocked.	Clean the outlet and the filter.
	The coffee grind is too fine.	Use only ground coffee for espresso machines.
	Scale build-up.	Perform a descaling cycle.

# Cleaning and care



EN

Problem	Possible causes	Solution
The  and  lights flash for a few seconds	Steam knob open	Close the steam knob.
	Boiler temperature too high.	Cool down the boiler.
	Scale build-up.	Perform a descaling cycle.
	No water in tank.	Fill the tank.
	Boiler outlet or filter blocked.	Clean the boiler outlet and the filter.
	The tank is not inserted correctly.	Insert the tank correctly in its housing.



If the problem has not been resolved or in the case of other types of fault, contact your local technical support centre.