

CONTEMPORARY

CHICAGO

BLACK OAK, TEXTURE [GRASS]

Black Oak finish with Tall Grass Texture & Black Glass top

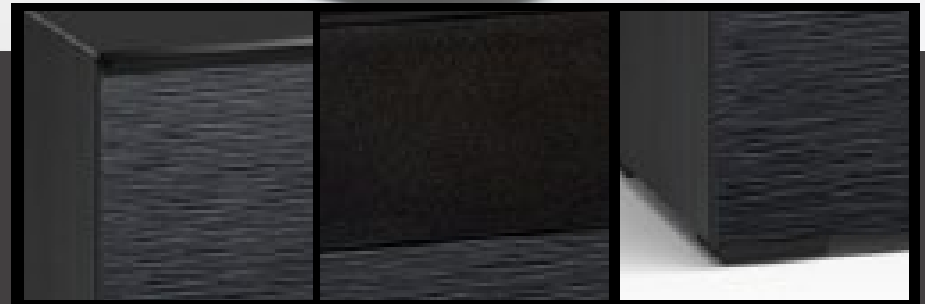

Textured Black Oak Doors

Black Speaker Grill

Hidden Adjustable Leveler



CHICAGO

BLACK OAK, TEXTURE [GRASS]

CONTEMPORARY

CHAMELEON COLLECTION



Chicago 217 23.25"W x 21.5"H x 21.25"D
Single Cabinet | C/CH217/BO
Subwoofer Enclosure | C/CH217SE/BO



Chicago 317 23.25"W x 31.25"H x 21.25"D
Single Cabinet | C/CH317/BO
Rack Mount Cabinet | C/CH317RM/BO



Chicago 517 23.25"W x 50.875"H x 21.25"D
Single Cabinet | C/CH517/BO
Rack Mount Cabinet | C/CH517RM/BO



Chicago 617 23.25"W x 60.625"H x 21.25"D
Single Cabinet | C/CH617/BO
Rack Mount Cabinet | C/CH617RM/BO



Chicago 221 44"W x 21.5"H x 21.25"D
Twin Cabinet | C/CH221/BO



Chicago 221 Corner 44"W x 21.5"H x 21.25"D
Twin Corner Cabinet | C/CH221CR/BO



Chicago 329 44"W x 31.25"H x 21.25"D
Twin Cabinet | C/CH329/BO



Chicago 329 Corner 44"W x 31.25"H x 21.25"D
Twin Corner Cabinet | C/CH329CR/BO



Chicago 323 44"W x 31.25"H x 21.25"D
Twin Cabinet | C/CH323/BO



Chicago 323 Corner 44"W x 31.25"H x 21.25"D
Twin Corner Cabinet | C/CH323CR/BO



Chicago 236 64.75"W x 21.5"H x 21.25"D
Triple Cabinet | C/CH236/BO



Chicago 237 64.75"W x 21.5"H x 21.25"D
Triple Cabinet | C/CH237/BO



Chicago 336 64.75"W x 31.25"H x 21.25"D
Triple Cabinet | C/CH336/BO



Chicago 337 64.75"W x 31.25"H x 21.25"D
Triple Cabinet | C/CH337/BO



Chicago 339 64.75"W x 31.25"H x 21.25"D
Triple Cabinet | C/CH339/BO



Chicago 245 85.5"W x 21.5"H x 21.25"D
Quad Cabinet | C/CH245/BO



Chicago 247 85.5"W x 21.5"H x 21.25"D
Quad Cabinet | C/CH247/BO



Chicago 345 85.5"W x 31.5"H x 21.25"D
Quad Cabinet | C/CH345/BO



Chicago 347 85.5"W x 31.25"H x 21.25"D
Quad Cabinet | C/CH347/BO

CR - Corner
RM - Rack Mount, Pro Audio
SUB - Subwoofer Enclosure
W - Wall Mountable



INTERIOR SPECIFICATIONS

A - Single-Width Compartment

19.75"W x 19.5"D x 17.75"H

B - Single-Width Compartment

19.75"W x 19.5"D x 27.75"H

C - Media Drawer

18.625"W x 18"D x 7.75"H

holds 75 DVD's and or 111 CD's upright

D - Single-Width Center Speaker / Multi-Functional Compartment

19.75"W x 19.5"D x 9"H

G - Double-Width Center Speaker / Multi-Functional Compartment

40.5"W x 19.5"D x 9"H

F - Triple-Width Center Speaker / Multi-Functional Compartment

61.25"W x 19.5"D x 9"H

J - Double-Width Compartment

40"W* x 19"D* x 17.5"H

H - Double-Width Compartment

40"W* x 19"D* x 27.75"H



217
SUBWOOFER ENCLOSURE
Includes Rear Speaker Grill



317
Rec. TV Size: up to 32"
Top Holds: 150 lbs

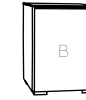

317
Rec. TV Size: up to 32"
Top Holds: 150 lbs

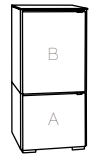

517
Rec. TV Size: up to 32"
Top Holds: 150 lbs

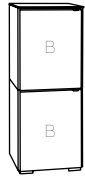

617
Rec. TV Size: up to 32"
Top Holds: 150 lbs

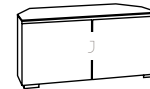

212 CORNER
Top Holds: 150 lbs

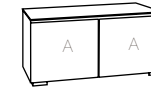

221
Rec. TV Size: up to 46"
Top Holds: 150 lbs

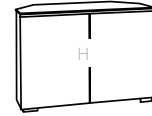

323 CORNER
Top Holds: 150 lbs

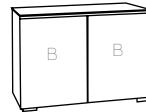

323
Rec. TV Size: up to 46"
Top Holds: 150 lbs

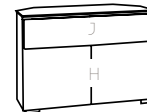

329 CORNER
Top Holds: 150 lbs

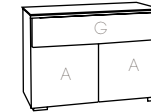

329
Rec. TV Size: up to 32"
Top Holds: 150 lbs

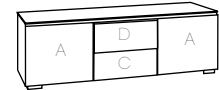

236
Rec. TV Size: up to 32"
Top Holds: 150 lbs

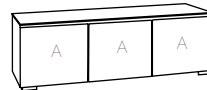

237
Rec. TV Size: up to 65"
Top Holds: 150 lbs

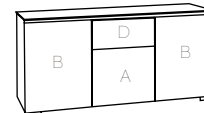

336
Rec. TV Size: up to 65"
Top Holds: 150 lbs

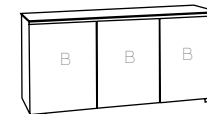

337
Rec. TV Size: up to 65"
Top Holds: 150 lbs

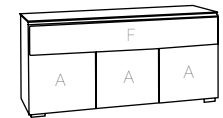

339
Rec. TV Size: up to 65"
Top Holds: 150 lbs

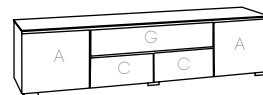

245
Rec. TV Size: up to 70"+
Top Holds: 150 lbs

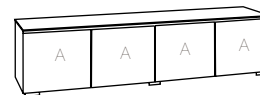

247
Rec. TV Size: up to 70"+
Top Holds: 150 lbs

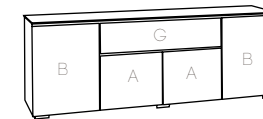

345
Rec. TV Size: up to 70"+
Top Holds: 150 lbs

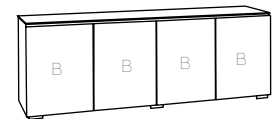

347
Rec. TV Size: up to 70"+
Top Holds: 150 lbs

INTERIOR SPECIFICATIONS

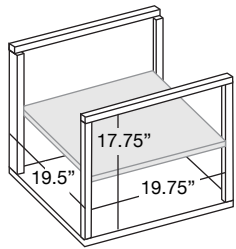

A

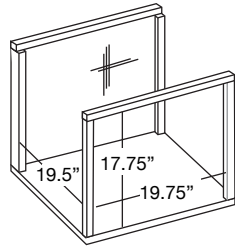

A1

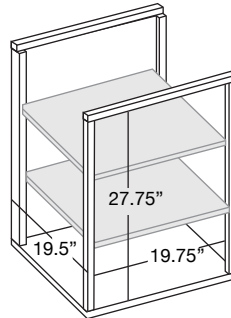

B

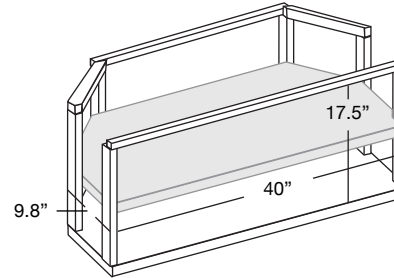

J

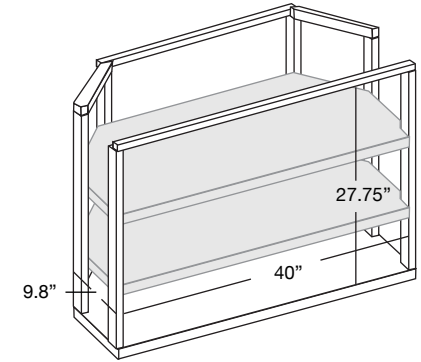

H

CORNER INTERIOR

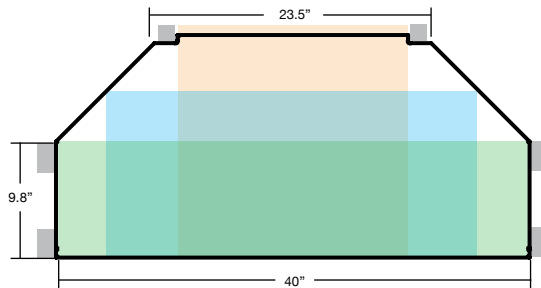

- 40" wide x 10" deep
- 32" wide x 14" deep
- 19" wide x 20" deep

CORNER EXTERIOR

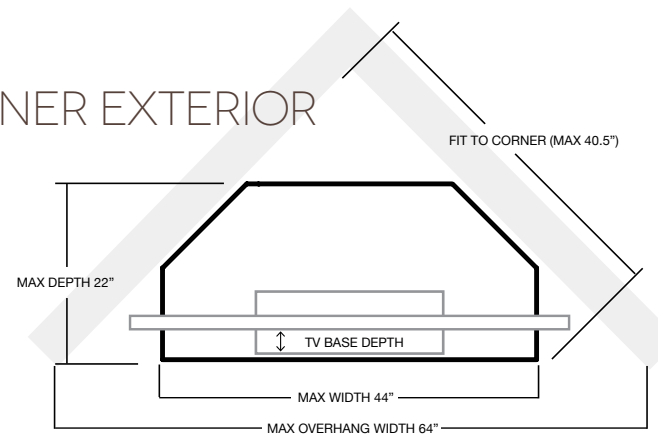

TV SIZING:

For every 1" of depth required by the TV base, subtract 1.8 from 64. This is the MAX TV width at the required depth. Note: Minor gains can be had by moving cabinet forward. This will cause a gap but will produce 1.8" in width per inch moved forward.